

*Eagle*  *Nest3*



**Anchorage tripod  
Model Eagle Nest 3**

Rel.18092019English



*Read this manual  
carefully and keep it  
for future reference*

## Ferno Technical Support

Customer Service and Technical Support are important aspects of every Ferno product. Before contacting us, note the serial number of the product and specify it in all written communications. For all queries concerning technical support, contact Ferno s.r.l.:

Telephone (toll-free in Italy)	800.501.711
Fax	+39 0516861508
E-mail	assistenza@ferno.it

## Ferno Customer Service

For assistance and further information, contact Ferno s.r.l.'s Customer Services:

### MANUFACTURER

Ferno s.r.l., Via Benedetto Zallone 26  
40066 - Pieve di Cento (BO) - ITALY

Telephone (toll-free in Italy)	800.501.711
Phone	+39 0516860028
Fax	+39 0516861508
Website	www.ferno.it

All patent rights, design rights, construction, reproduction, use and sale relating to any item covered in this manual are the confidential and exclusive property of Ferno s.r.l., except for rights expressly transferred to third parties or not attributable to parties owned by the supplier. It is prohibited to reproduce this manual, either in full or in part, without the prior consent of Ferno s.r.l.

## Limited warranty

Ferno products are covered by a 24-month warranty against manufacturing defects. For the full terms and conditions of warranty and liability, see **chapter 8 Warranty, page 21**.

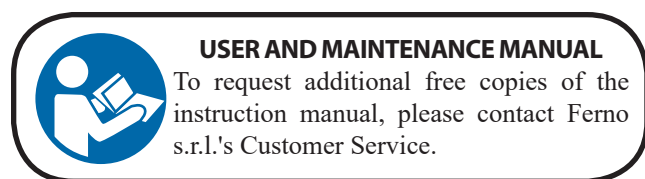

## Limitation of liability

This manual contains general instructions on the use and maintenance of the product. The instructions do not cover all possible applications and operations. The user is solely responsible for proper and safe use of the product. The safety information is provided as a service to the user and ensures only the minimum required level of safety to prevent injury to operators and patients. Any other safety measure implemented by the user must comply with applicable regulations. Before using the product, it is strongly recommended that staff be trained in its correct usage. Retain this manual for future reference. In case of change of ownership, ensure that the manual remains with the product. Additional free copies can be obtained from Ferno s.r.l.'s Customer Service.

## Intellectual property declaration

The information in this manual is the property of Ferno s.r.l. - Via Benedetto Zallone 26, 40066 Pieve di Cento (Bologna) Italy.

## TABLE OF CONTENTS

Chapter/Section	Page
Ferno Technical Support _____	2
Ferno Customer Service _____	2
Limitation of liability _____	2
Intellectual property declaration _____	2
Limited warranty _____	2
<b>1 - WARNING _____</b>	<b>4</b>
1.1 Warning _____	4
1.2 Important _____	4
1.3 Blood-borne diseases _____	4
1.4 Load capacity _____	4
1.5 Glossary of symbols _____	4
1.6 Operator training _____	4
1.7 Definitions _____	5
1.8 Information and safety labels _____	5
<b>2 - OPERATOR TRAINING AND SKILLS _____</b>	<b>7</b>
2.1 Skills _____	7
2.2 Training _____	7
<b>3 - THE DEVICE _____</b>	<b>7</b>
3.1 Description _____	7
3.2 EC Conformity _____	8
<b>4 - COMPONENTS (EAGLE NEST 3) _____</b>	<b>9</b>
4.1 General specifications _____	10
<b>5 - EAGLE NEST 3 CONFIGURATION _____</b>	<b>12</b>
5.1 Initial setup _____	12
5.2 Leg positioning and assembly _____	12
5.3 Head assembly _____	14
5.4 Third leg assembly on the Eagle Nest 3 _____	15
5.5 Positioning procedure for the upper head anchorage system _____	17
5.6 Installation procedure for the base rope _____	18
<b>6 - MAINTENANCE _____</b>	<b>19</b>
6.1 Routine and preventive maintenance _____	19
6.2 Cleaning the device _____	20
<b>7 - TECHNICAL SUPPORT _____</b>	<b>21</b>
Technical Support Service _____	21
<b>8 - WARRANTY _____</b>	<b>21</b>
<b>9- Main rules for usage of the eagle nest and of fall-arresting ppe _____</b>	<b>23</b>
<b>Periodical inspection log _____</b>	<b>26</b>
<b>Training record _____</b>	<b>27</b>

# 1 - SAFETY INFORMATION

## 1.1 Warning

The danger symbols draw attention to potentially dangerous situations that, if disregarded, may result in accidents, damage and/or injury.

**WARNING**

**Untrained users may injure themselves, cause damage and/or physical harm. Allow only trained and qualified staff to use the device.**

**Improper preparation of the device may cause damage and / or injury. Prepare and use the device as described in this manual.**

**Occasional assistants may cause damage and/or physical harm, or injure themselves. Always keep the device under control, activate the controls, and coordinate the assistants.**

**The operators must always be secured against the risk of falls from height using adequate fall arresting devices compliant with relevant regulations.**

**Improper maintenance may cause serious accidents, injuries and/or damage. Perform maintenance as described in this user manual.**

**Improper maintenance may cause serious accidents, injuries and/or damage. Perform maintenance as instructed in this user manual.**

**The use of improper and/or unauthorised devices may cause accidents, damage, and/or injury. Use only devices that have been approved and authorised by Ferno s.r.l..**

**Unauthorised modifications can cause injury and / or damage. Use the device only as approved by Ferno.**

**Unauthorised overhauls and repairs carried out by people not approved by Ferno s.r.l., will render all warranties null and void and may compromise the safety of the device.**

**Non-original spare parts and inadequate repairs may cause damage and/or injury. Use only original Ferno parts and refer exclusively to Ferno s.r.l. Customer Support.**

**A rescue plan must be prepared for any emergencies that could arise during work.**

**The operators' health conditions may affect the safety of the device user in normal and emergency conditions.**

**The user must inspect the device before and after each use.**

**The device must not be used in case of sharp edges on the head.**

## 1.2 Important

Boxes labelled "Important" contain important information on use and/or maintenance of the device.

**Important**

## 1.3 Blood-borne diseases

To reduce the risk of exposure to infectious diseases that may be transmitted by blood, such as HIV-1 or Hepatitis, follow the instructions on disinfection and cleaning in this manual carefully.

## 1.4 Load capacity

Observe the load capacity of the Eagle Nest device. Refer to **section 4.1 General specifications, page 10.**

## 1.5 Glossary of symbols

The symbols used in this manual and/or on the device's labels are defined below. The CE mark is present on the device and in this manual.



Load capacity (in pounds, kilos and stone)



Danger: Risk of injury



2008 is the notified body in charge of monitoring the product



Do Not Lubricate



Lubricate



Read the user manual carefully

## 1.6 Operator training

Operators who use the Eagle Nest must:

- Carefully read and understand all information in this manual.
- Attend a suitable training course on the use of the device.
- Have received specific training on the emergency medical service and patient handling procedures in case of emergency.
- Possess the physical skills required to assist the patient.
- Record the training sessions on the **form on page 27.**
- Not disregard the use limits of the Eagle Nest 3 nor fail to comply with the intended use described in this manual.







### 1.7 Definitions

- **TRANSPORT BAG:** allows to carry the device once it has been disassembled and reconditioned
- **FOOT:** leg support system with ball joint (14-22-40 mm diameter) for any type of pole: ice studs, snow poles and climbing studs, allowing anchorage on irregular or slippery surfaces
- **BASE COLLAR:** anchorage system at the base of the foot used to fix the rope or to support the recovery system
- **ROPE:** textile fibre length adjusting system. When the rope is correctly fitted into the base collar it prevents feet from slipping because of any stress
- **LEG - EXTRACTABLE ELEMENT:** first section of the leg assembled on the foot. It includes two telescopic tubes for height adjustment
- **LEG - FIXED ELEMENT:** second section of the leg fitted in contact to the head
- **HEAD:** upper connecting element for the legs and restraint system for the operator's suspension system
- **FALL PROTECTION ANCHORAGE POINT:** sole central anchorage point resulting from the combination of the holes on the elements of the head



### 1.8 Information and safety labels

Safety labels contain important information for the user:



- **CE2008** - Notified body in charge of monitoring the product.
- **EN 795:2012** - The product is certified according to standards EN795:2012, type B and CEN/TS 16415:2013 (Eagle Nest 3) and type A (Eagle Nest 2) for use by three people.
- **MM/YY** - Month and year of manufacture.
- **Model/code** - Product code.
- **Product** - Product type.
- **Serial Number** - Unique product identification.

 	
 <p>Read and fully understand operator's manual before using the product</p> <p><b>Standard(s):</b> EN 795:2012 type B CEN/TS 16415:2013 type B</p> <p>   2008 For 3 people use         </p>	<p><b>Manufacturer:</b> Ferno Washington Italia srl</p> <hr/> <p><b>Product:</b> Tripod Anchor Device   <b>Model/code:</b> Eagle Nest 3</p> <p>  <b>MM/YY:</b> _____         </p> <p><b>Serial Number:</b> _____</p> <p>  Legal headquarters and Commercial offices Via B. Zallone n. 26   ✉ info@ferno.it 40066 Pieve di Cento [BO]   Italy   P +39 051 6860028   F +39 051 6861508         </p>

*The label is on the head of the Eagle Nest.*

 		
<b>Maintenance record:</b>		
<b>Date</b>	<b>Maintenance Performed</b>	<b>By</b>
<b>Next maintenance date:</b>		
_____		

*Maintenance label*

	
<b>Manufacturer:</b> Ferno Washington Italia	
<b>Product:</b> Tripod Anchor Device	<b>Model/code:</b> Eagle Nest 3
 <b>MM/YY:</b> _____	
<b>Serial Number:</b> _____	
 Legal headquarters and Commercial offices Via B. Zallone n. 26   40066 Pieve di Cento [BO]   Italy P +39 051 6860028   F +39 051 6861508   ✉ info@ferno.it	

*Packaging label*

## 2 - OPERATOR TRAINING AND SKILLS

### 2.1 Skills

Operators who use the device must:

- have adequate training knowledge to face the risks arising from preparation and use of the device;
- the personnel in charge must have gained adequate experience in a protected environment (training) to install and use this device;
- record the training sessions on the form on **page 27**.

### 2.2 Training

Operators are required to:

- read and understand all information in this manual;
- attend a suitable training course on the use of the device;
- invest time to specific training on how to use the device and repeat them over time even in case of frequent use.

#### Important

Ferno s.r.l. is not liable for damages caused to users and / or third parties arising from improper use of the device, or in case Eagle Nest is used with a device not approved by Ferno s.r.l.

#### **WARNING**

**Any configuration unauthorised by Ferno s.r.l. could cause damage and/or serious injury. If used in a different configuration, contact the Technical Service team at Ferno s.r.l. directly. (see page 2).**

#### **WARNING**

**Untrained users may injure themselves, cause damage and/or physical harm. Allow only trained and qualified staff to use the device.**

## 3 - THE DEVICE

### 3.1 Description

The EAGLE NEST 3 is an anchorage device designed to prevent falls from a height, wholly manufactured in titanium. It is included in the category of mobile anchorages and certified in accordance with EN 795/2015 regulation.

All components of the anchorage system are manufactured and assembled in compliance with the resistance requirements in EN 795:2012 regulation.

The EAGLE NEST 3 device has been tested for three users maximum, according to EN 795:2012 type B and CEN/TS 16415:2013, type B.

Its operators need adequate information and training before use.



Read the user manual  
carefully

## EAGLE NEST 3

### LIST OF COMPONENTS

- Transport bag.
- No. 3 feet with ball joint (aluminium).
- No. 3 legs - extractable element made of titanium tubes gr. 9.
- No. 3 legs - fixed element made of titanium tubes gr. 9.
- No. 1 head (aluminium).
- No. 12 locking pins (zinc-coated iron).
- No. 1 polyester rope connecting the feet (code: Double Braid PES rope with 5,58m).
- No. 1 head ring (code: 7W103120STD) for upper fastening to the anchorage point.
- No. 1 zinc-coated steel head connector (code: 3C4650A).
- No. 5 chain connectors EN362 (product code: 2C44600 YRC).
- User's manual.



### 3.2 EC Conformity

The EC conformity of Eagle Nest 3 was established as per Regulation (EU) 2016/425.

The conformity assessment procedure described in Module B of the EU Regulation 2016/425 was carried out by Dolomiticert Scarl, Z.I. Villanova 7/a, 32013 Longarone (BL) – Italy (Notified body no. 2008).

For further information: [www.ferno.it](http://www.ferno.it)



Regulation on personal protective equipment.

This product complies with the requirements of EU Regulation 2016/425 on PPE.

For further information and to read the EU declaration of conformity visit our website: [www.ferno.it](http://www.ferno.it)

### LOCKING PIN

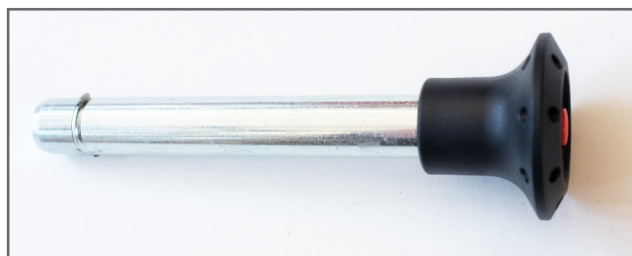

#### WARNING

**Improper use of the device may cause damage and / or injury. Use the device as described in this manual. The device must not be used out of its limits**

#### WARNING

**Ensure the suitability of the surface where the device will be installed.**



## 4 - COMPONENTS (EAGLE NEST 3)

### EAGLE NEST 3 FRONT VIEW

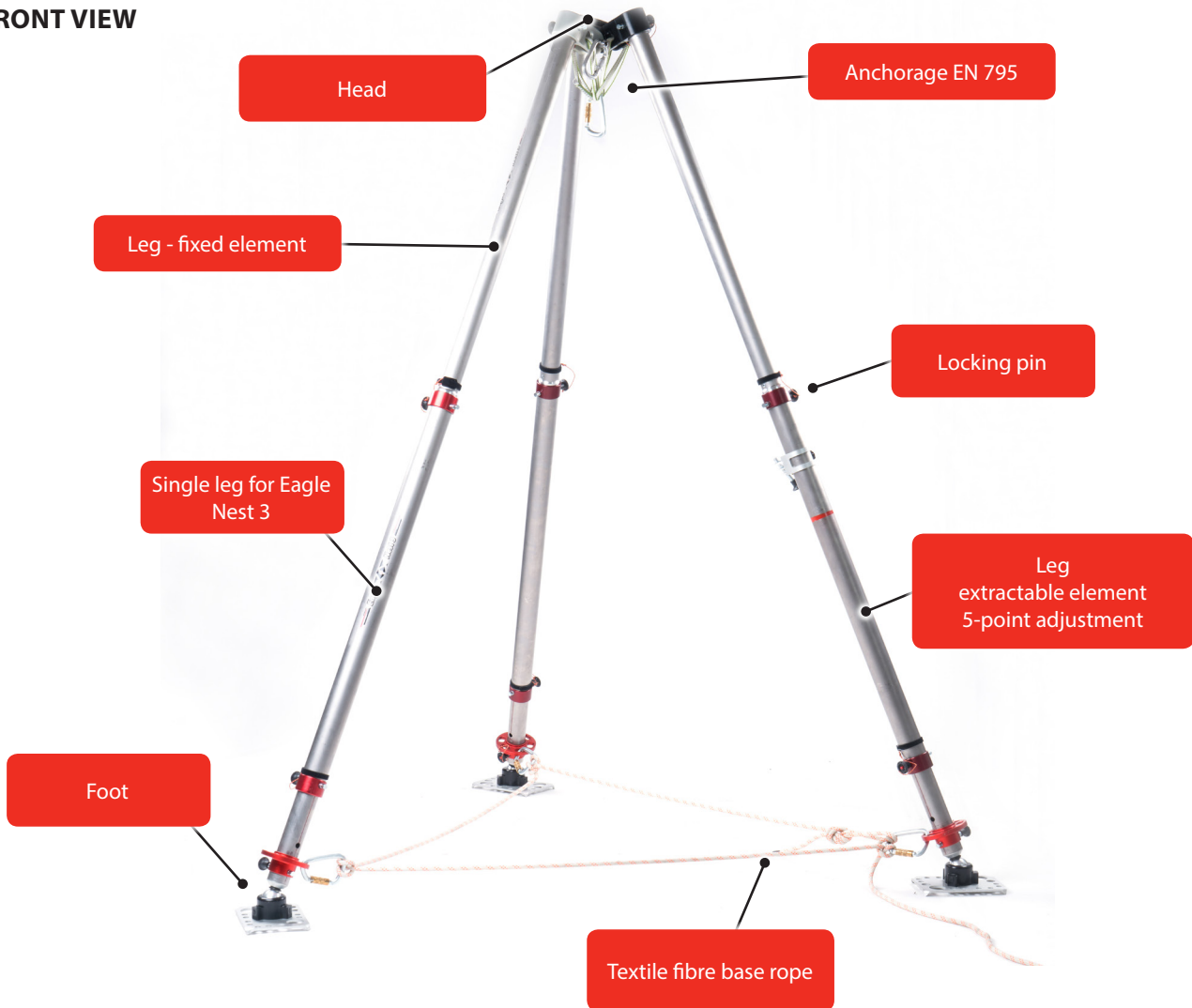

### TRANSPORT BAG

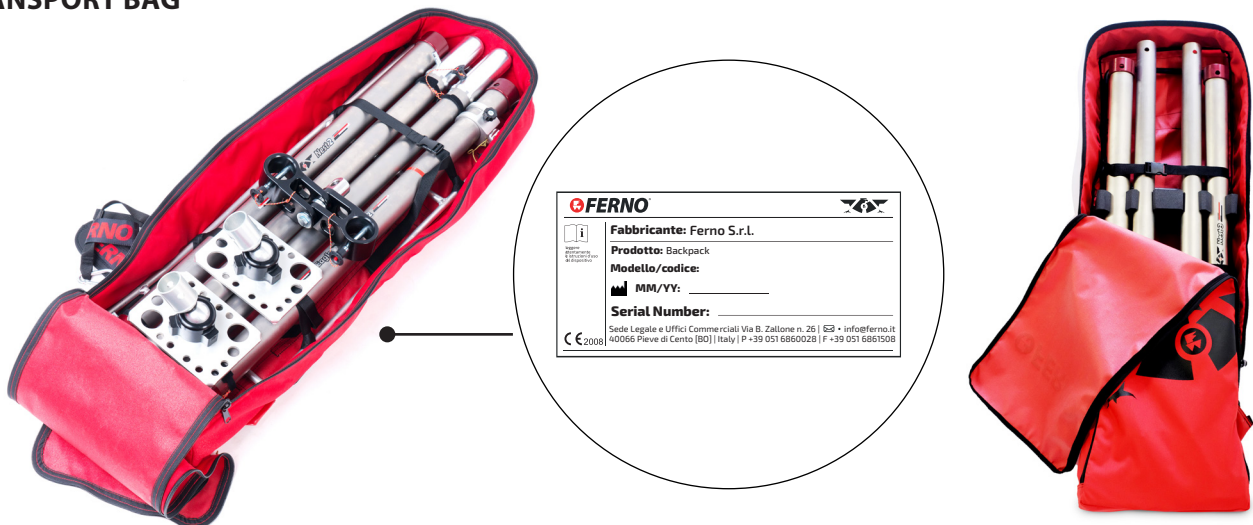

## Eagle Nest Tripod

### Maximum height

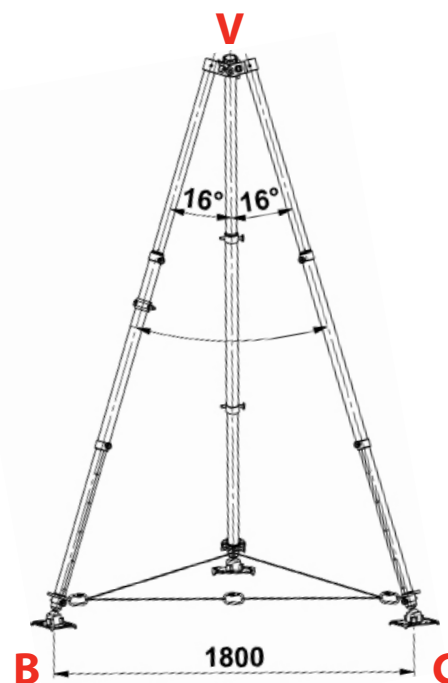
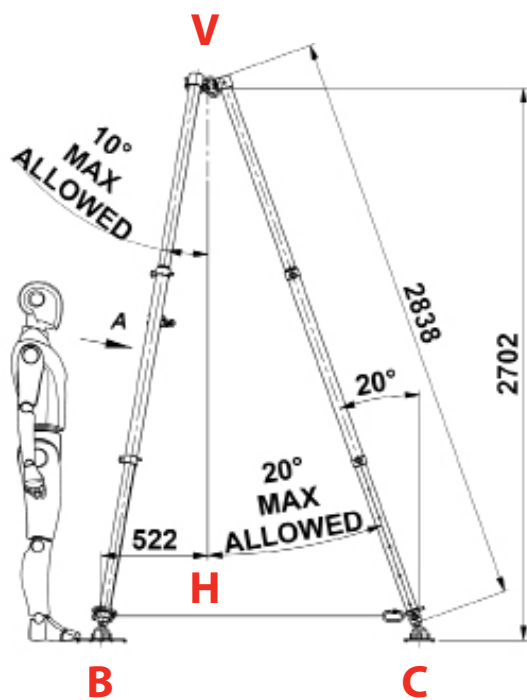
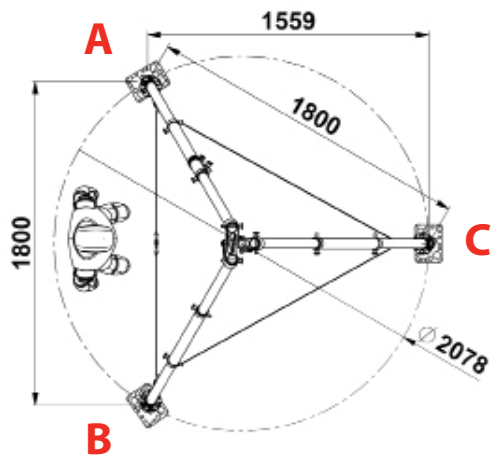

The leg inclination is different

## 4.1 General specifications

### General use:

- As PPE against falls from a height.
- No ground anchorage.
- Protection against slipping (surface).
- The stability of the anchorage device must be guaranteed.
- The anchorage device must always be kept in vertical position (compared to its horizontal axes).
- The head must always be at the centre of the tripod.
- A detailed check-list for the routine inspection of the device can be found on **page 19**.
- The minimum resistance is 20 kN.

Specifications		
Load capacity*	3 Kn	300 kg
Weight*	50.7 lbs	23 kg
Operating dimensions		
Maximum height	106.37 in	2702 mm
Minimum height	73.78 in	1874 mm
Volume: inside the transport bag		
1400 x 400 x 200 mm		
5.11 x 15.74 x 7.87 in		

Distance between legs	
A - B	1800 mm
A - C	1800 mm
B - C	1800 mm
Angles	
A V B	32°
B V H	10°
C V H	20°
Leg extension	
Maximum extension	2838 mm
Minimum extension	2088 mm

Minimum height

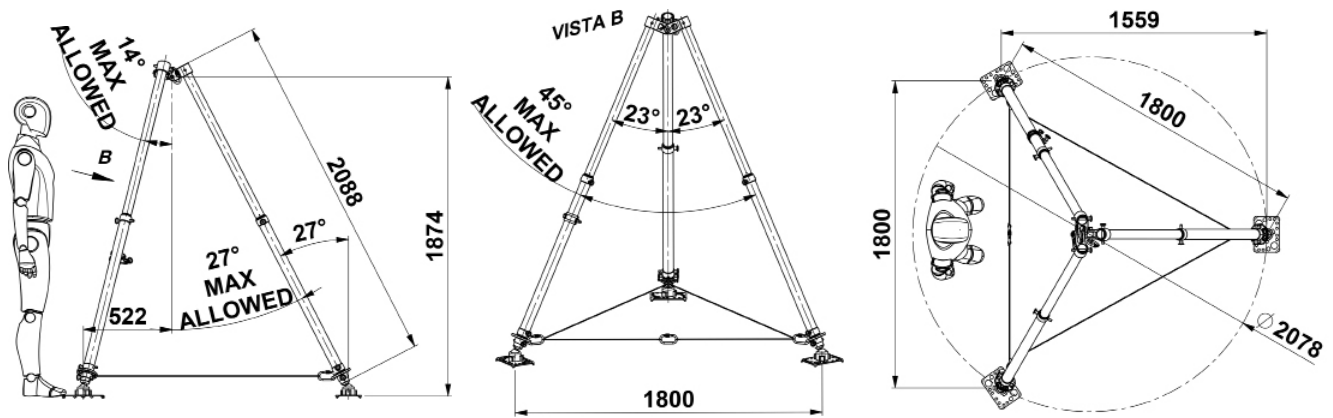

Single leg for Eagle Nest 3

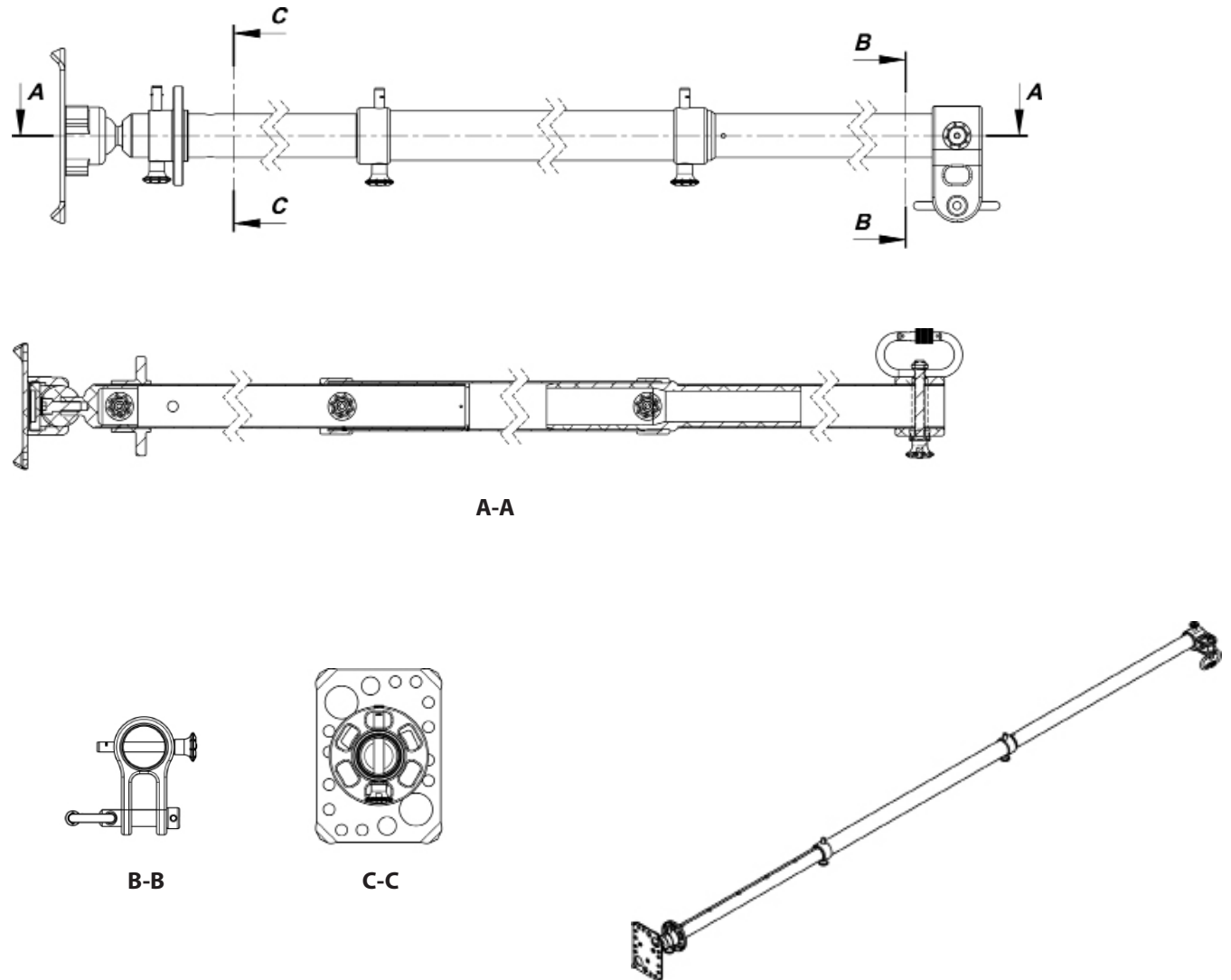

## 5 - EAGLE NEST 3 CONFIGURATION

### 5.1 Initial setup

Before using the Eagle Nest device:

- Wear suitable PPE against foreseeable risks.
- Check the good conditions of each element composing the device.
- Components supplied with the device (see **chapter 3.1, page 7**).
- Pay attention to any dangers arising from the use of equipment combinations where the safety function of one element is affected by or interferes with the safety function of another one.
- In a fall-arresting system, the harness EN 361 must be used in combination with an energy absorber EN 355, a lanyard EN 354, and a connector EN 362, or a retractable device EN 360.

**⚠ WARNING**

**Mainly used on flat structures (approx. + / - 1 °).**

**⚠ WARNING**

**the anchorage device should only be installed by qualified personnel or organisations.**

### 5.2 Leg positioning and assembly



Prepare the legs - extractable element considering the expected final layout.

Adjust the length of the leg - extractable element. The Eagle Nest height is easily adjustable thanks to the small holes on its legs.



Position the leg on the desired hole and insert the locking pin.



Insert the leg - fixed element.



Lock the two elements with the specially provided pin.

●**Note:** insert instructions for the maximum differential adjustment of the device feet in case of irregular surfaces (only a differential adjustment of one hole between a leg and the other is possible, see test report).



Follow the red line to find the hole and insert the pin quickly.  
In case of irregular surfaces, a different adjustment of the legs is permitted, with a maximum difference of one hole between a leg and the other.



Insert the ball-jointed foot at the end of the leg. The ball joint allows to adapt the Eagle Nest 3 to any inclination of the legs.



Lock the two elements with the specially provided pin.

### 5.3 Head assembly



Insert the head on the terminal end of the leg - fixed element and secure the elements with the specific pin.



Lock the head on the leg holes and insert the pin. Repeat the same operation for the other leg.

### 5.4 - Third leg assembly on the Eagle Nest 3



Place the grey head close to the head assembly.

**WARNING**

the anchorage device should only be installed by qualified personnel or organisations.



Insert the pin in the hole of the grey head.



Lock the head with the snap hook.



Use the provided pin to secure the third leg to the head.



Lock the third leg with the pin.



Insert the third leg - extractable element.



Lock the two elements with the specially provided pin. At the end of installation, use the leg adjustment system - extendible leg to adapt the height and the anchorage point centring.

 **WARNING**

**The load line where users will be suspended must always be vertical compared to the structure.**

 **WARNING**

**In case of irregular surfaces, the adjustment of the device feet can differ by maximum one hole between a leg and the other. However, the load must always be inside the area of the three poles.**



## 5.5 Positioning procedure for the upper head anchorage system



1 - Arrange the anchorage system for fall protection paying attention to surround all three head elements.

2 - The textile ring must comply with applicable regulations; only use the sling supplied with the device.

3 - The connector EN 362 hooked to the textile ring must contain all 3 holes and comply with applicable regulations. Only use the connector supplied with the device.

The connector installed on the head sling allows to connect the operator's fall protection system to the anchorage device.



The picture shows how to insert the connector in all the holes of the head.

### **WARNING**

**Make sure that the anchorage device is installed on a stable surface that is suitable for its use.**

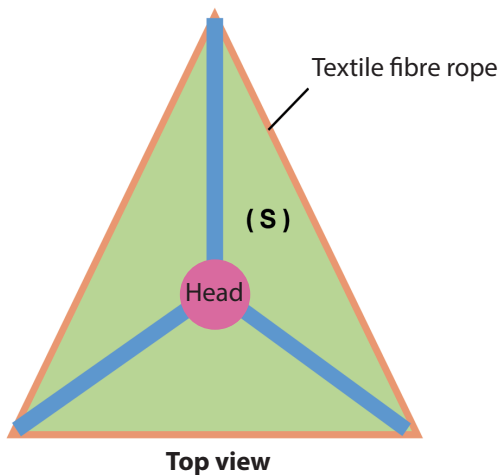

Head vertical axis must always be inside the working area (s), i.e. inside the triangle formed by the base rope.

### **WARNING**

**The inclination of each leg is showed in detail in figures on [page 10](#).**

## 5.6 Installation procedure for the base rope

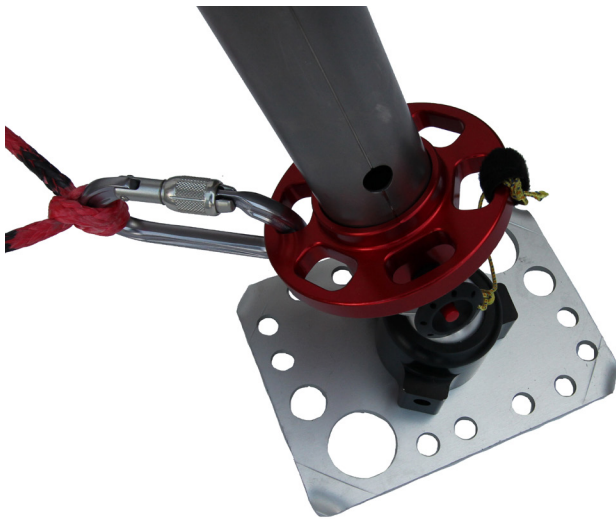

In order to install a base rope, insert the three snap hooks in the suitable slots on the red discs located at the end of the legs (extractable element) of the Eagle Nest 3.

Repeat the operation for all three legs of the device.



Ferno strongly recommends to use the base rope supplied with the Eagle Nest 3.

## 6 - MAINTENANCE

### 6.1 Routine and preventive maintenance

The Eagle Nest is a technical device requiring regular maintenance, hence you are recommended to comply with the following schedule:

- ROUTINE maintenance:** must be performed by the Manufacturer at intervals not exceeding 12 months. Ferno engineers will issue a conformity certificate of the medical device after maintenance.
- ROUTINE inspection:** preventive inspection checks have to be performed by the user according to the table below. It has to be performed each time the device is used. We suggest that every 12 months the inspection is performed by a different operator.

Minimum preventive maintenance intervals	After each use	Every month
Disinfection		
Cleaning		•
Inspection	•	•
Lubrication - At least every 6 months		
Screw check - At least every 6 months		

- EXTRAORDINARY inspection:** must be performed after problems have occurred endangering the efficiency of the device. Its frequency cannot be foreseen. In these cases check the system following the list of possible problems as below:

#### Check-list of extraordinary inspection

If one of the following problems occurs the EAGLE NET must be temporarily dismissed:

- Identification data of the device cannot be read (e.g. serial number)
- Not all components are available at the same time as required by the information sheet
- The movement of the feet in the different ranges is blocked or even only limited
- Presence, even partial, of corrosion or dirt
- Signs of corrosion or contact with chemical reagents, solvents or fuels, especially in the textile fibre parts

- The base rope is not completely efficient

*NOTE: the device can only be made available again to be used after the problem has been solved.*

**If one of the following defects occurs, the EAGLE NEST must be discontinued:**

- Presence of dents or signs of perforation, even minimum, in the tubes composing the legs
- Presence of deformations which could alter the alignment of tubes composing the legs
- Difficult or impossible insertion or extraction of the locking pins
- Excessive play of the elements in the insertion points
- Signs of corrosion or contact with chemical reagents, solvents or fuels which could reduce resistance
- Modifications not authorized by the Manufacturer
- In case of arrest of a serious fall or, in any case, after any stress higher than the declared capacity

#### CHECK-LIST FOR THE ROUTINE INSPECTION OF THE DEVICE

- Are all the components present?
- Does the device show signs of wear?
- Are all screws, bolts, and pins in place?
- Do all the moving parts work properly?
- Do all the locking devices work properly?
- Ferno base rope: is it in full working order and compliant with inspection requirements?
- Non-Ferno base rope: is it in full working order and compliant with inspection and load requirements?

#### After the INSPECTION:

*- Doubts about the integrity of the device may be confirmed and therefore it must be discontinued;*

*- A positive assessment can be possible and therefore the device is made available again. However the overhaul must be written on the control sheet and the subsequent date for overhaul must be scheduled.*

#### WARNING

**It is recommended to record the date of the next or last inspection on the device.**

## INSPECTION OF TEXTILE PARTS

Make sure that all textile parts and stitching are free from cuts, abrasion, frayed borders, wear, corrosion, burns and signs of chemical substances; also check that no thread is cut, frayed or loose; finger rope devices all along their length to check that their internal core is free from cuts, empty points, breaking, swelling (any problems in the core are invisible and can be caused by overexertion, local bends, dirt). During every use: check that the product works properly, and that any other component of the system is well connected and arranged; pay attention to the effects of humidity and frost, as they can compromise the device operation; avoid the contact with sharp edges and, if necessary, use protective equipment; for the operator's safety, the device or the anchorage point must always be correctly positioned and the operation must be performed so as to minimise risks.

4. **Repair:** extraordinary action to make the device available again for use. This action can only be carried out by the Manufacturer.

If the device undergoes particularly heavy use, maintenance of the Eagle Nest should preferably be carried out on a more frequent basis. If there are signs of wear and damage, discontinue use of the Eagle Nest and immediately contact Ferno's Technical Support Service. Ferno directly carries out repair maintenance operations, without the need of dealers, mechanics or external service centres. You are thus invited to be wary of those who present themselves as Ferno's authorised technician. We suggest you to directly contact our SOS service using the reference contacts.

## 6.2 Cleaning the device

1. Eagle Nest is highly resistant to corrosion. Therefore if you need to clean its metal parts you can use water, sponge, and detergents you commonly use everyday.

In case the movement of the joints of the feet is not fluid enough you can use silicone spray to facilitate it.

1. Clean the surfaces of the device with a cloth, warm water and a non-abrasive mild detergent.
2. If necessary, remove stains with a stiff bristle brush (not metal), or a light solvent, paying attention to the labels.
3. Dry with a cloth.

Do not wash with high pressure water or with water jets.

After cleaning, be sure to complete the device in all its parts, in case together with all the other accessories needed for use.

## CLEANING OF TEXTILE PARTS

1. Remove the textile parts from the product.
2. Place them inside a mesh bag (not supplied with the products) and put it in the washing machine.
3. Wash in hot water, using a cleaning and disinfecting product and selecting a cycle for delicate items, with slow spin. Do not bleach.
4. Remove the restraints from the mesh bag and let them dry in the open air. Do not tumble dry.
5. Re-fit the restraints only once they are dry.

### **WARNING**

**Let the device dry naturally, if it gets wet during use or cleaning.  
Keep away from direct heat.**

### **WARNING**

**Improper maintenance may cause serious accidents, injuries and/or damage. Perform maintenance as instructed in this user manual.**

### **Important**

When not in use, store the device in an indoor environment that is dry and protected from direct sunlight.

### **Important**

After disinfection / cleaning, ensure that the device and its components are completely dry before use.

### **Important**

During cleaning and maintenance pay special attention in removing any textile or plastic component to avoid damaging it.

### **WARNING**

**Lubricating the parts that do not have to be lubricated results in dust and particle deposits inside the lubricated parts and causes damage.  
Only lubricate the ball joint of the foot.**

### **WARNING**

**For the use and cleaning of textile parts (ropes, rings, etc.) refer to the manufacturer's instructions.**

## Useful life

**METAL PARTS:** The useful life of the product is unlimited, provided that no specific cause damages it, and periodical inspections are carried out at least every 12 months from the first use date, with the relevant results recorded in the product sheet.

**TEXTILE PARTS:** The useful life is 10 years from their first use and in any case, even considering storage, it cannot exceed 12 years from the manufacture (e.g. year of manufacture 2014, useful life until the end of 2026). Such useful life is calculated provided that no specific cause damage the parts, and periodical inspections are carried out at least every 12 months from the first use date, with the relevant results recorded in the product sheet.

**METAL / TEXTILE PARTS:** The following factors may reduce the life of the product: intensive use, damage to product components, contact with chemical substances, high temperatures, abrasion, cuts, violent impacts, incorrect use or storage. When in doubt about the product's safety, contact FERNO or your dealer.

**TRANSPORT:** Protect the product from the risks mentioned above.

### **WARNING**

**Cleaning, maintenance or disinfection products, according to their intended use, must not have negative effects for PPE or users.**

## 7 - TECHNICAL SUPPORT

### Technical Support Service

For technical support concerning our products, contact the Ferno s.r.l. Technical Support Service.

Telephone (toll-free in Italy)	800.501.711
Phone	+39 0516860028
Fax	+39 0516861508
E-mail	assistenza@ferno.it
Website	www.ferno.it

For information on using the Eagle Nest device, and to schedule training courses on the correct use of the device, contact the Ferno s.r.l. Customer Service team.

### **WARNING**

**Non-original spare parts and inadequate repairs may cause damage and/or injury. Use only original spare parts and refer exclusively to Ferno s.r.l. Customer Support.**

### **WARNING**

**Unauthorised modification of device could cause serious damage, injury and / or unforeseeable operating problems. Do not modify or alter the device in any way.**

## 8 - WARRANTY

### Warranty Terms and Conditions

Ferno's products are guaranteed against manufacturing defects for a period of 24 months from the date on the Ferno s.r.l. shipping document.

Ferno s.r.l. guarantees its spare parts for a period of 12 months.

During the warranty period, Ferno will repair and/or replace any parts found to have manufacturing defects free of charge.

Collection and maintenance of the device are included in warranty (to be borne by Ferno), while the right to call and the sending of the technician are EXCLUDED by the maintenance at the customer's site.

The warranty does not cover consumables or parts subject to wear and tear due to normal use of the product, all parts typically subjected to impacts, sliding or rolling friction (bearings, brushes, lubricants, shoes, tracks, etc.), parts potentially exposed to oxidation or corrosion (copper or metal alloy contacts, electrical, electronic and mechanical equipment).

The surface finishes (gelcoat/resin, paint, powder paint, decals, tape, inscriptions, etc.) are guaranteed for 90 days.

Repairs are performed by trained technical staff at the Washington Ferno Italia s.r.l. site in Via Zallone 26- 40066 Pieve di Cento (BO), or at the Customer's premises if suitable arrangements with Ferno s.r.l.'s Customer Service have been made.

Technical support at the Customer's premises must be arranged beforehand with the Technical Support Service.

The intervention provides that the right to call and the sending of the technician will be charged.

Repairs are guaranteed for 6 months from the date of repair. This warranty applies only when the product is used according to the instructions in the user manual provided. Misuse and negligence invalidate this warranty.

The warranty is valid from the day the product is shipped from Ferno s.r.l.

Ferno s.r.l. is not liable for damages sustained during shipment or due to misuse of the product.

The warranty is rendered null and void in the case of:

- failure to observe the operating instructions,
- misuse,
- inappropriate use or handling,
- repairs by non-authorized persons,
- damage during transport due to improper packaging of items returned by the user,
- inadequate maintenance,
- failure to use original spare parts.

In cases not covered by the warranty, Ferno s.r.l. will not cover the transport costs for sending or returning the product.

## Limitation of liability

If a product is found to be defective, Ferno s.r.l. will repair or replace it.

The following cases are not covered by warranty:

- labels or plates bearing the manufacturer's logo, the serial or registration number, which have been tampered with;
- the product that has undergone modifications, repairs or treatment by personnel not authorised by Ferno s.r.l.;
- the product not used in compliance with the instructions, or used for purposes other than those for which it was designed.

## Warranty claims

Contact Ferno's Customer Service immediately if you receive a product that is suspected to be defective. A representative will assist the customer through the complaints procedure. Before returning a product to Ferno s.r.l., contact the Customer Service to request authorisation.

## Claims

Any claims must be communicated to the reseller, or to Ferno s.r.l.'s Customer Service, within 5 days of receipt of the product or of discovery of the alleged defect.

## Return authorisation

No product will be accepted without the prior approval of Ferno s.r.l.

Products returned for business reasons, or for reasons not relating to nonconformity of the product, will be accepted only after verification by Ferno s.r.l. authorised personnel.

## 9 - MAIN RULES FOR USAGE OF THE EAGLE NEST AND OF FALL-ARRESTING PPE

- PPE must be used by duly trained and informed personnel.
- PPE cannot be used by personnel judged unfit further to a technical evaluation or by inadequately trained personnel.
- All the personnel using PPE must know the procedures for use and for evacuation required and agreed between the parties.
- Any modification to the device without the written consent of the Manufacturer is forbidden.
- Any repair to the devices must be performed by the Manufacturer or by a Centre authorised by the Manufacturer.
- PPE must be used only for the purposes for which they have been designed.
- PPE must be used in compliance with ergonomic and sanitary requirements stipulated by the regulations in force.
- Before using the device a functional check of the different assembled elements must be performed. This check will have to be performed by one of the operators who will use it. The operator has to be adequately trained on how to use the device correctly.
- All PPE must be checked according to the recommendations of the reference standard and they will have to be found in excellent working conditions to avoid any failure or breakage when in use.
- During the inspection phase all PPE must be checked, paying particular attention to signs of damage due to wear and tear, shocks, corrosion, cutting or any other cause for malfunctioning according to the instructions of the Manufacturer. With special reference to:
  - Harness
  - Fall-arresting systems
  - Recovery systems
  - Positioning systems
  - Ropes, slings, webbings and possible tangles
  - Connectors and any accidental contacts or torsions
  - Any other system involved with the use of the EAGLE NEST

PPE must be periodically inspected by the Manufacturer or by personnel authorised by the Manufacturer for periodical inspection and maintenance. The frequency of periodical inspections must not exceed 12 months. The inspection must be carried out on each element accurately to prevent any cause for malfunctioning. Special attention must be paid to damages due to wear and tear, shocks, corrosion, cutting or any other cause for expected malfunctioning. The result of the inspection will have to be recorded in the specially provided control sheet and the subsequent date for inspection will have to be scheduled.

- The frequency of the periodical inspections is fundamental for the conditions of the device and for the safety of the operators, which depends on the conditions of the device as far as resistance and good functioning are concerned.
- During the periodical inspection all markings must be checked and they have to be readable.

• All the information regarding the device (name, serial number, date of purchase, date of first use, name of the user, information regarding maintenance, repair, inspections and decommissioning) must be recorded in the control sheet. The owner of the device will be held responsible to enter the data in the specially provided control sheet, to be performed by the personnel in charge of this task. The use of the PPE is forbidden if the relevant control sheet has not been duly filled in.

### WARNING

**For safety reasons, it is fundamental that the anchorage device or another point are always well positioned, and that the operation is carried out so as to minimise the risk of potential falls and the potential falling height.**

### WARNING

**For safety reasons, before each use it is fundamental to check the free space requested by the user on the workplace so that, in case of falls, there is no impact with the ground or other obstacles on the way down. Refer to table on page 25.**

The device must be equipped with adequate instructions for use made by the Manufacturer; to be written in the language of the country where it has been sold. In case, the translation of the instructions for use in a language different from that of the Manufacturer will be at the reseller's charge. The manual must include instructions for use, for preservation, for periodical inspection and for repairs in the official language of the country where the device will be used.

- PPE must be immediately discontinued in case of any doubt concerning their functional integrity. It is only possible to make the PPE available again on condition that the Manufacturer or personnel appointed by the Manufacturer performs a detailed inspection and updates the control sheet.

- Fall-arresting PPE must be discontinued and destroyed (or dismantled) after a fall arrest.

- The only PPE permitted for protection against falls from a height is the complete body harness compliant with EN 361 and connected to the provided points for fall arrest. It is forbidden to connect it to points which are not those provided for fall arrest or which are only partially considered suitable for fall arrest.

- The fall-arresting anchorage point (compliant with EN 795) must always be above the user. This point must always guarantee stability and limitation of free fall to the minimum. The form and the construction of the anchorage point of the device must guarantee a permanent connection of the devices and cannot cause its accidental detachment.

- It is compulsory for the user to evaluate the most adequate fall-arresting system to be used, considering also the air draught in the specific working setting.

- During all the useful life of the device the users must take care of constantly controlling correct operation also considering the specific situations of use.

- The devices must be transported, stocked and kept according to the Manufacturer's instructions.

- The EAGLE NEST must be transported in the specially provided bag with which it has been sold.

- The EAGLE NEST must be stocked inside the specially provided bag with which it has been sold. Before the parts can be put and stocked inside the bag they must be dried.

- When used by a single operator, the maximum transmitted load is 9 kN, and when used by multiple operators (up to 3) the maximum transmitted load is 12 kN.

- When the anchorage device is integrated in a fall-arresting system, the user must be equipped with a system to limit the dynamic force generated by the user during the fall arrest up to 6 kN maximum.

### Important

Pay attention and inspect the device components once again when one of the following conditions occurs:

- extreme temperatures, out of the operating range
- 40 °C ÷ + 50 °C
- contact with chemical substances
- clear abrasion of the components
- components with sharp edges that could cut the ropes

### Important

Should the product be resold out of the original installation country, it is crucial for the user's safety that the reseller supplies all instructions for use, maintenance, periodical inspection and repair in the language of the country where the device will be used.



The Eagle Nest has been submitted to a dynamic resistance and integrity test. This table shows the peak displacement values. These data allow the user to calculate the minimum air draught under their feet so that any impact is avoided on the way down. Keep in mind the following data.

Leg configuration	Peak strength (kN)	Maximum deflection (mm)	Residual deflection (mm)
Symmetrical	12	40	30
Asymmetrical	12	35	23

**INSPECTION SHEET**

DEVICE INSPECTION SHEET		
IDENTIFICATION		
Product: <b>Eagle Nest 3</b>	Manufacturer: FERNO	
Purchased on:	First used on:	Expiry date:
Year of manufacture:	Serial number:	Batch number:
User:	Company:	
INSPECTION CHECK-LIST		
<p><u>If one of the following problems occurs the EAGLE NET must be temporarily dismissed:</u></p> <ul style="list-style-type: none"> <li>p. Identification data of the device cannot be read (e.g. serial number)</li> <li>q. Not all components are available at the same time as required by the information sheet</li> <li>r. The movement of the feet in the different ranges is blocked or even only limited</li> <li>s. Presence, even partial, of corrosion or dirt</li> <li>t. Signs of corrosion or contact with chemical reagents, solvents or fuels, especially on the textile parts</li> <li>u. The base rope is not completely efficient</li> </ul> <p>NOTE THE DEVICE CAN ONLY BE USED AGAIN AFTER THE PROBLEM HAS BEEN SOLVED.</p> <p><u>If one of the following defects occurs, the EAGLE NEST must be discontinued:</u></p> <ul style="list-style-type: none"> <li>w. Presence of dents or signs of perforation, even minimum, in the leg tubes</li> <li>x. Presence of deformations which could alter the alignment of tubes composing the legs</li> <li>y. Difficult or impossible insertion or extraction of the locking pins</li> <li>z. Excessive play of the elements in the insertion points</li> <li>aa. Signs of corrosion or contact with chemical reagents, solvents or fuels which could reduce resistance</li> <li>bb. Modifications not authorized by the Manufacturer</li> <li>cc. In case of a serious fall or after any stress higher than the declared capacity</li> </ul>		







*Product User and Maintenance Manual, required to operate the product safely, maintain its efficiency and reliability, and comply with the terms of the warranty.*

**Rel.18092019 English**

**Ferno s.r.l.**

Via Benedetto Zallone 26

40066 - Pieve di Cento (BO) - ITALY

Telephone (toll-free for Italy)	800.501.711
Phone	+39 0516860028
Fax	+39 0516861508
E-mail	info@ferno.it
Website	www.ferno.it